

OCST 740-HZ

REFRIGERATING CAPACITY (kW)

	Tc		
	-10	-5	0
40	7,14	9,18	11,56
45	6,22	8,06	10,20
50	5,30	6,97	8,87

POWER CONSUMPTION (kW)

	Tc		
	-10	-5	0
40	3,32	3,70	4,06
45	3,35	3,79	4,20
50	3,35	3,85	4,31

Tc : Condensation temperature
Te : Evaporation temperature

Condenser

Condenser	
Compressor Model	TAG 4553 Z
Compressor Brand	Tecumseh
Compressor Type	Hermetic
Refrigerant	R404A
Voltage	380 V / 3 / 50 Hz

Chassis	
Chassis	TK 500"1021S"1x500
Fin Spacing	2,1 mm
Fan	1 x Ø 500 mm
Fan Brand	Embpapst
Consump. Capacity	680 Watt
Air Volume	5402,1 m ³ /h
Surface Area	33,89 m ²

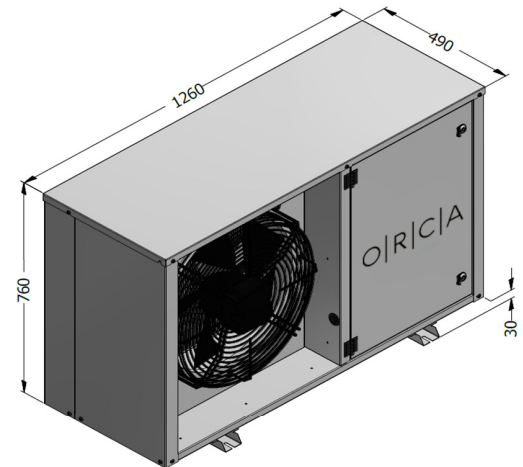

Evaporator

Evaporator	
Evaporator	ORE 30.42.6
Fin Spacing	6 mm
Defrost	E1 4 x 400 Watt
Expansion	TV
Fan	4 x Ø 300 mm
Fan Brand	Ebmpapst
Consump. Capacity	288 Watt
Air Volume	4340 m ³ /h
Surface Area	28,8 m ²
Number of Evap.	1

E : Electric
TV : Thermostatic valve

Pipe Diameters (inches)	
Suction Line	3/4"
Liquid Refrigerant Line	1/2"

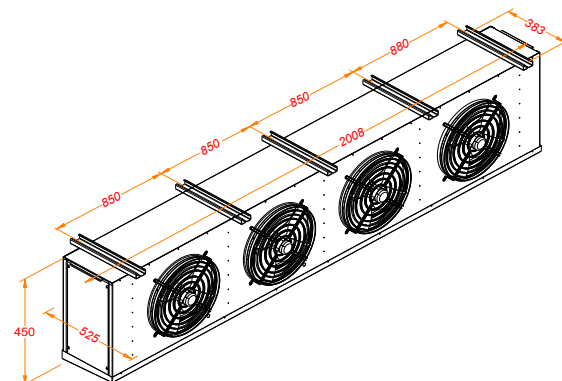

P: +90 212 694 58 58
F: +90 212 694 58 59

info@tekop.com.tr

Gokevler Mah. 2245 Sok.
No:7 Holpark Sit.
Esenyurt/Istanbul/TURKEY