

OCIT 565-SZ

REFRIGERATING CAPACITY (kW)

Tc	Te		
	-10	-5	0
40	28.56	34.28	40.70
45	25.96	31.21	37.09
50	23.32	28.09	33.44

POWER CONSUMPTION (kW)

Tc	Te		
	-10	-5	0
40	10.91	11.77	12.46
45	11.35	12.38	13.27
50	11.73	12.92	13.99

Tc : Condensation temperature
Te : Evaporation temperature

Condenser

Condenser	
Compressor Model	H1501CC
Compressor Brand	Dorin
Compressor Type	Semi Hermetic
Refrigerant	R404A
Voltage	400 V / 3 / 50 Hz

Chassis	TK 500x4
Fin Spacing	2,1 mm
Fan	4 x Ø 500 mm
Fan Brand	Ebmpapst
Consump. Capacity	2720 Watt
Air Volume	22346 m ³ /h
Surface Area	90.36 m ²

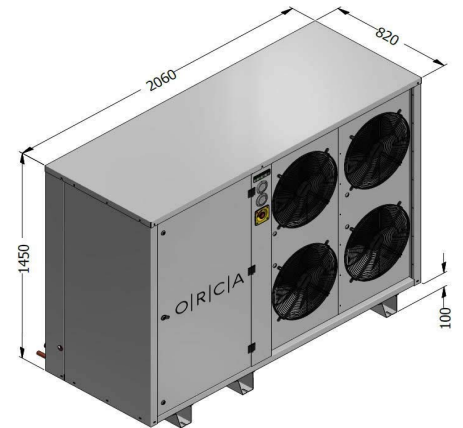

Evaporator

Evaporator	ORE 50.32.6
Fin Spacing	6 mm
Defrost	E1 12 x 800 Watt
Expansion	TV
Fan	3 x Ø 500 mm
Fan Brand	Ebmpapst
Consump. Capacity	2040 Watt
Air Volume	17520 m ³ /h
Surface Area	131.5 m ²
Number of Evap.	1

E : Electric
TV : Thermostatic valve

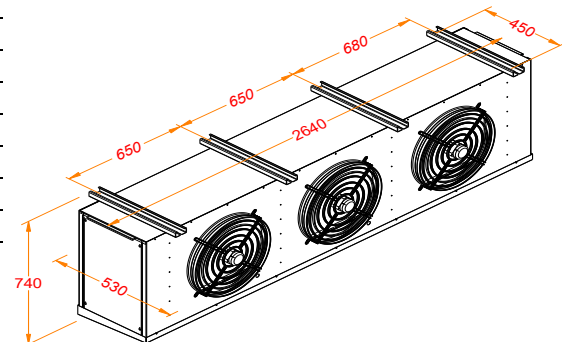

Pipe Diameters (inches)	
Suction Line	1 5/8"
Liquid Refrigerant Line	1 1/8"

P:+90 212 694 58 58
F:+90 212 694 58 59

info@tekop.com.tr

Gokevler Mah. 2245 Sok.
No:7 Holpark Sit.
Esenyurt/Istanbul/TURKEY